









## LED 3011

833.77.020	833.77.041	833.77.057
833.77.030	833.77.050	833.77.058
833.77.040	833.77.051	833.77.053
833.77.021	833.77.052	833.77.054
833.77.031	833.77.056	833.77.055

24 V System		K	W	T <sub>A</sub>	 mm	 mm			
<b>A</b>	833.77.020	3000 K	0.9 W	-20 °C – +35 °C -4 °F – +95 °F	330 x 8.0 x 2.5	≥ 340 x 18 x 3.5			
	833.77.030	4000 K							
	833.77.040	5000 K							
	833.77.021	3000 K	5.6 W		2000 x 8.0 x 2.5	≥ 2010 x 18 x 3.5			
	833.77.031	4000 K							
833.77.041	5000 K								
<b>B</b>	833.77.050	3000 K	0.4 W		166.5 x 8.0 x 2.5	≥ 176.5 x 18 x 3.5			
	833.77.051	4000 K							
	833.77.052	5000 K							
<b>C</b>	833.77.056	3000 K	0.4 W		156.5 x 8.0 x 2.5	≥ 166.5 x 18 x 3.5			
	833.77.057	4000 K							
<b>D</b>	833.77.058	5000 K	0.4 W	156.5 x 8.0 x 2.5	≥ 166.5 x 18 x 3.5				
	833.77.053	3000 K							
	833.77.054	4000 K							
	833.77.055	5000 K					833.77.900 833.77.901 833.77.912 833.77.913 833.77.914 833.77.915		

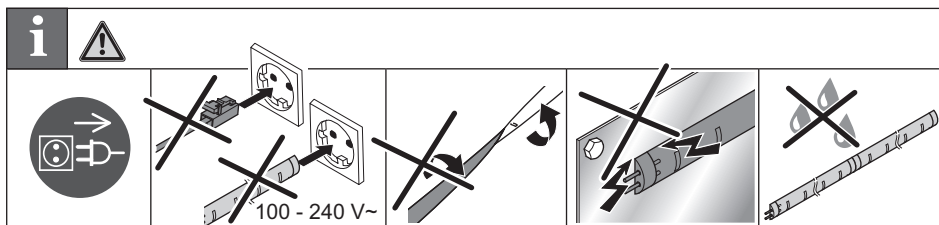
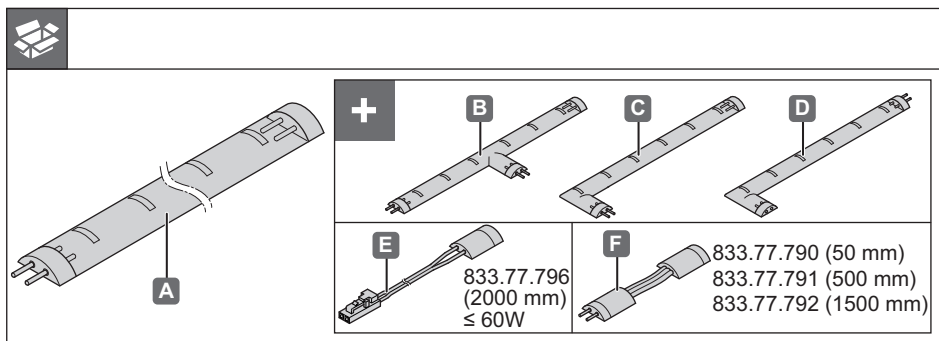

HDE 11.12.2012

732.28.285

