

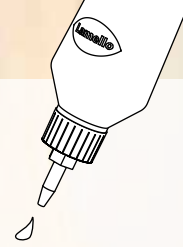

Tenso P-14



Ideal glue aid for materials
from 13mm thickness

Without glue clamps

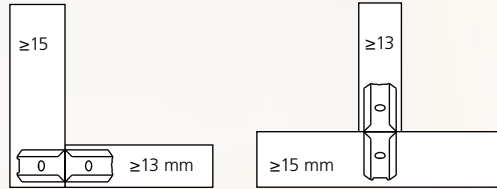

New



Applications

- 90° butt-joints from 13mm
- **For fixed glue-joints in**
 - Drawer sides and fronts
 - Joining room dividing elements
 - Kitchen facings and plinths
 - Cover panels, face frames
 - Column coverings and door frames
 - Work pieces with finished spray-painted surfaces
 - Furniture which is shipped assembled i.e. sideboards, bathroom furniture, kitchen cabinets

Installation

With Zeta P2
or CNC machine

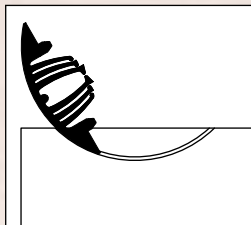
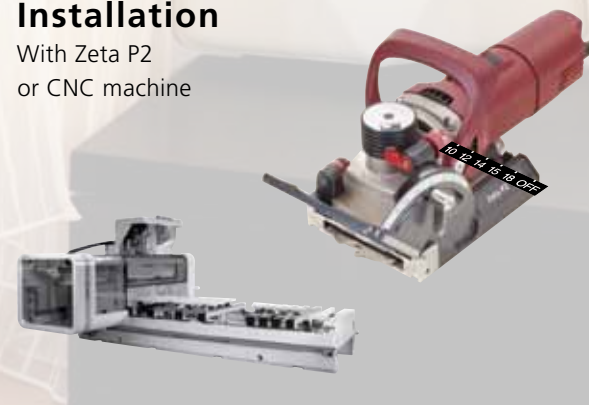

fast

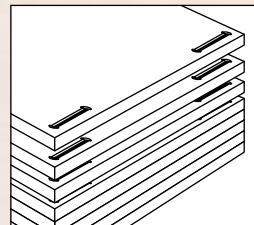

stackable

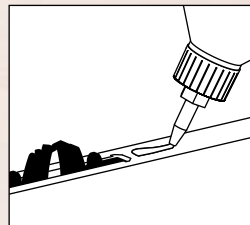

gluing aid

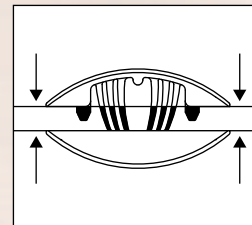

self-clamping

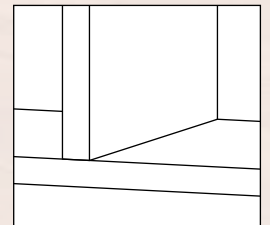

invisible

Tenso P-14

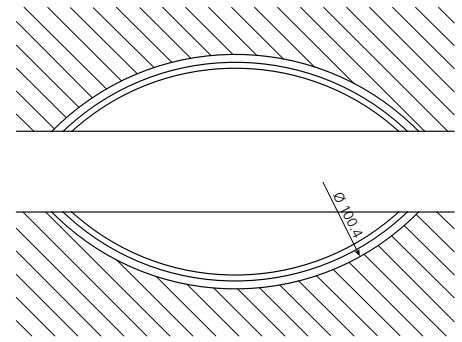
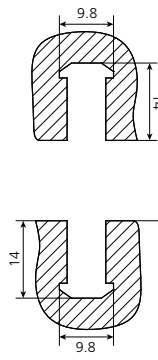
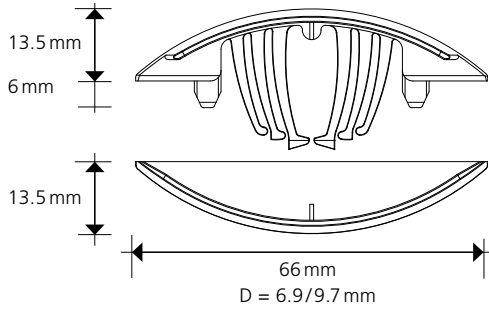

Tensile Force: 15 kg

Retention Force: 25 kg

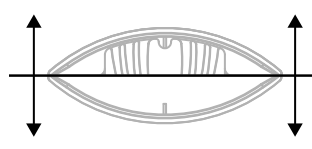
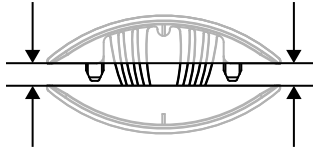

Tip: Sample joining with Bisco P-15 possible

Tenso P-14



Bisco P-15



pairs	Art. No.
80	145410
300	145420
1000	145431

pieces	Art. No.
80	145301
300	145302
1000	145303

Accessories



Clamex P cutter, DP	Art.No.
100.4 × 7 × 30 / DTK 48 mm.....	132142
100.4 × 7 × 40 / DTK 52 mm.....	132143
100.4 × 7 × 16 / DTK 28 mm.....	132144



Cutter arbor 30 / DTK 48 mm	Art.No.
S 20 × 50, L = 102 mm.....	132150
S 25 × 60, L = 102 mm.....	132151
S 16 × 50, L = 85 mm.....	132152
S 16 × 55, L = 68 mm.....	132153
S 16 × 50, L = 85 mm "Weldon"	132154
S 20 × 50, L = 85 mm "Weldon"	132155



Glue applicator Minicol	Art.No.
with pointed nozzle.....	175551

More P-System fittings

Clamex P Medius 15/10



pairs	Art. No.
80	145377
300	145378

Clamex P-15



pairs	Art. No.
80	145337
300	145342
1000	145352

Clamex P-10



pairs	Art. No.
80	145382
300	145383
1000	145384

Bisco P-10



pieces	Art. No.
80	145304
300	145305

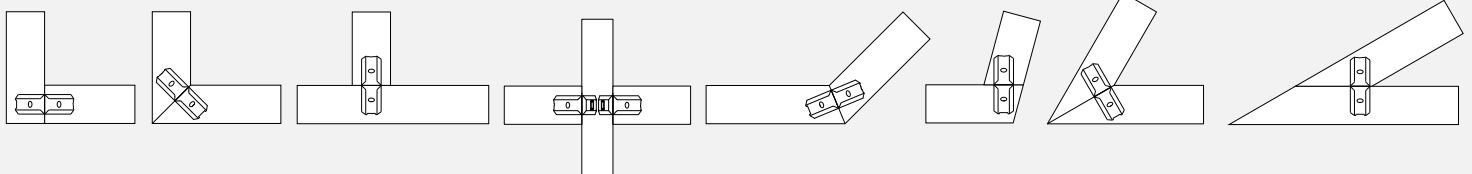

Manufacturer:

Lamello AG
Verbindungstechnik
 Hauptstrasse 149
 CH-4416 Bubendorf
 Tel. +41 61 935 36 36
 Fax +41 61 935 36 06
 info@lamello.com
 www.lamello.com