

Häfele Slido Classic 40-I to 120-I Sliding door fitting

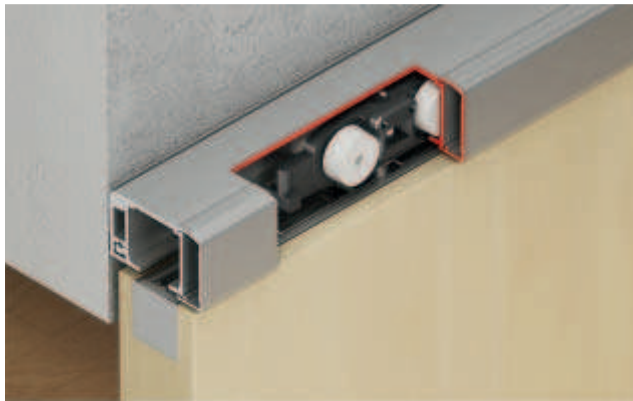

- > Area of application: For 1-leaf and 2-leaf sliding doors
- > Door weight: ≤40/80/120 kg
- > Adjustment facility: Door height adjustable ±3 mm
- > Installation: Wall mounting and ceiling installation, suspension with integrated support flange

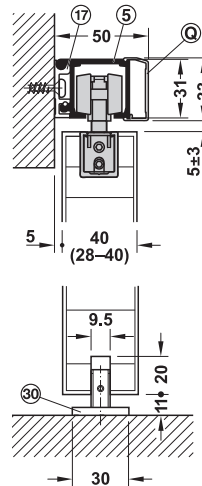

Wall mounting with mounting rail and clear threshold floor guide without guide track

Sliding Door Fittings for Wooden Doors

Section guide and trolley hanger

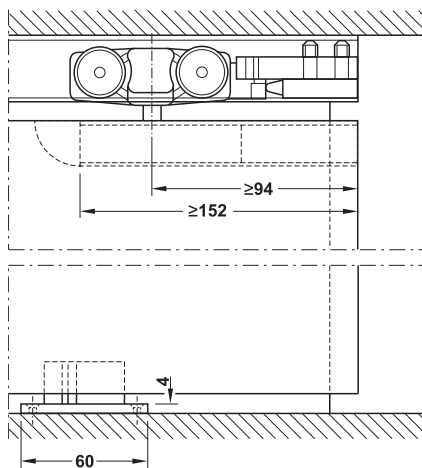

Soft closing versions overview

Without soft and self closing mechanism

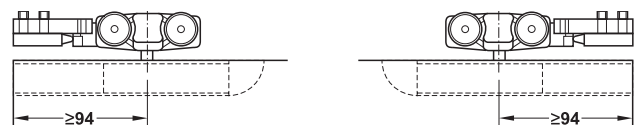

With soft and self closing mechanism on one side

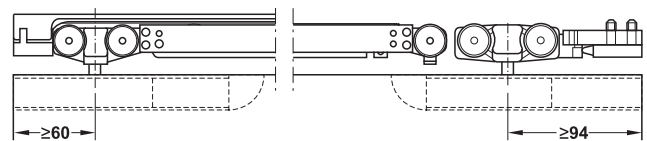

With soft and self closing mechanism on both sides

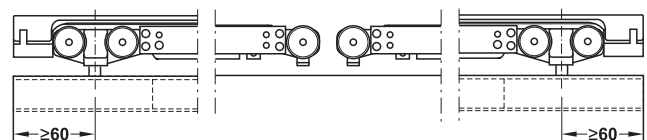

Routing dimensions

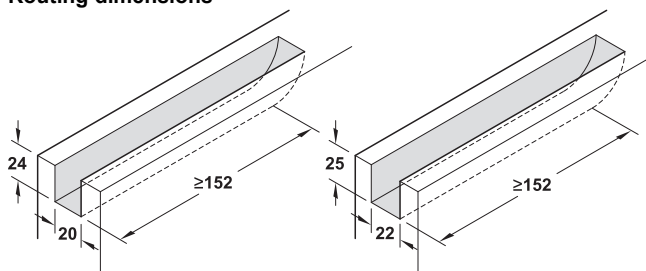

40-I

80-I and 120-I

9



DGH-B 2015, HDE-en, 06/15; Dimensional data not binding. We reserve the right to alter specifications without notice.

→ Set with running track for 1 door

	Version	Supplied with	Door width mm	80-I ≤80 kg per door
Wall mounting with mounting rail	Without soft and self closing mechanism	1 80-I set 1 mounting rail (17) 2000 mm 1 running track (5) 2000 mm with threaded end inserts 1 panel (Q) 2000 mm with end caps	–	940.82.235
	With soft and self closing mechanism on one side	1 80-I set 1 mounting rail (17) 2000 mm 1 running track (5) 2000 mm with threaded end inserts 1 panel (Q) 2000 mm with end caps	≥594	940.82.236
	With soft and self closing mechanism on both sides	1 80-I set 1 mounting rail (17) 3000 mm 1 running track (5) 3000 mm with threaded end inserts 1 panel (Q) 3000 mm with end caps	≥920	940.82.237

→ Set without running track for 1 door

Version	Supplied with	Door width mm	40-I ≤40 kg per door	80-I ≤80 kg per door	120-I ≤120 kg per door
Without soft and self closing mechanism	2 running gears 1 clear threshold floor guide 2 track buffers with retaining spring	–	940.43.081	940.82.148	941.25.005
With soft and self closing mechanism on one side	2 running gears (1 with soft and self closing mechanism) 1 clear threshold floor guide 1 track buffer with retaining spring 1 release device with stopper for soft and self closing mechanism	≥594 (40–80 kg) ≥683 (120 kg)	940.43.082	940.82.149	941.25.006
With soft and self closing mechanism on both sides	2 running gears with soft and self closing mechanism 1 clear threshold floor guide 2 release device with stopper for soft and self closing mechanism	≥920 (40–80 kg) ≥1098 (120 kg)	940.43.084	940.82.152	941.25.007

Order reference

Please order track, panels and accessories separately. Order 2 sets for 2-leaf sliding doors.
Please order adjustment aid for adjusting the running gears (height and position) separately.

Fixing options for Häfele Slido Classic 40-I to 120-I sliding door fitting

Wall mounting with mounting rail

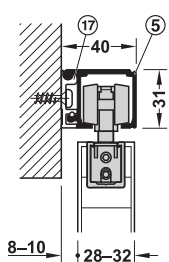

With running track (5), mounting rail (17) width 8 mm

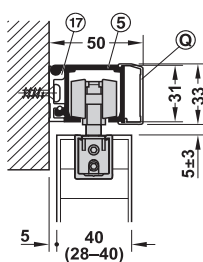

With running track (5), mounting rail (17) width 8 mm and clip panel (Q)

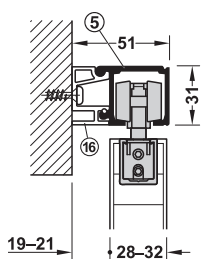

With running track (5), mounting rail (16) width 19 mm

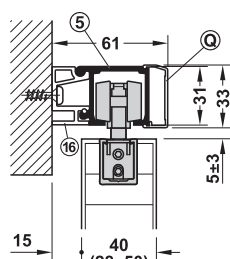

With running track (5), mounting rail (16) width 19 mm and clip panel (Q)

Ceiling installation

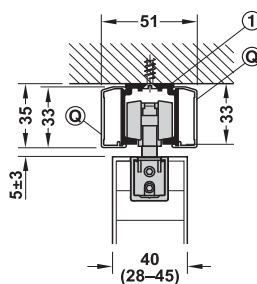

With running track (1) and 2 x clip panel (Q)

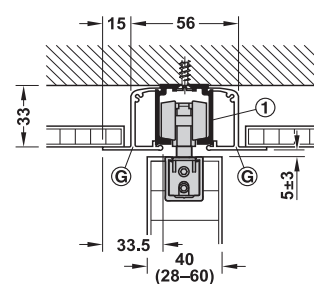

With running track (1) and 2 x clip panel (G)

Guides

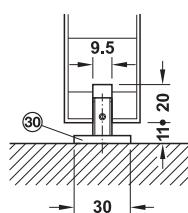

Clear threshold floor guide (30), without guide track

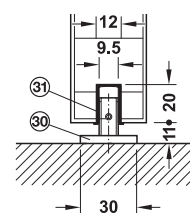

Clear threshold floor guide (30), with guide track (31)

DGH-B 2015, HDE-en, 06/15; Dimensional data not binding. We reserve the right to alter specifications without notice.



→ Tracks

			Area of application	Material	Finish/colour	Length mm	Cat. No.			
Wall mounting and ceiling installation										
Single running track, pre-drilled, 31 x 33 mm (W x H)	①		For door weight 40–120 kg	Aluminium	Bright	2000	940.43.921			
						3000	940.43.931			
						6000	940.43.961			
								Silver coloured anodized	2000	940.43.922
									3000	940.43.932
									6000	940.43.962
Wall mounting										
Single running track	⑤		For door weight 40–120 kg	Aluminium	Silver coloured anodized	2000	941.25.920			
						3000	941.25.930			
						6000	941.25.960			
Mounting rail, pre-drilled, width 19 mm	⑬		For door weight 40–120 kg	Aluminium	Silver coloured anodized	2000	941.25.821			
						3000	941.25.831			
						6000	941.25.861			
Mounting rail, pre-drilled, width 8 mm	⑰		For door weight 40–120 kg	Aluminium	Silver coloured anodized	2000	941.25.820			
						3000	941.25.830			
						6000	941.25.860			
Ceiling installation										
Double running track, pre-drilled, 70 x 33 mm (W x H)	③		For door weight 40–120 kg	Aluminium	Silver coloured anodized	2000	941.02.920			
						3000	941.02.930			
						6000	941.02.960			
Double running track, pre-drilled, 81 x 33 mm (W x H)	④		For door weight 40–120 kg	Aluminium	Silver coloured anodized	2000	941.02.820			
						3000	941.02.830			
						6000	941.02.860			

Note

Aluminium bright running track cannot be used in combination with a clip panel.

Order reference

Please order threaded end insert for running track ⑤ and mounting rail ⑬ or ⑰ separately.

Installation (running track ⑤ and mounting rail ⑬ or ⑰)

Slide in threaded end insert at rail ends. The running track and mounting rail ends must be fixed with glue points when installed between walls.

→ Mounting bracket and accessories



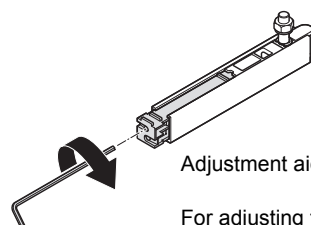

			Area of application	Material	Finish/colour	Length L	Wall distance track centre mm	Cat. No.
Mounting bracket with screw and nut (install every 400 mm)	⑩		For running track ①	Steel	Galvanized	36	16–25	940.42.061
						44	18–33	940.62.061
						64	33–55	940.42.063
Threaded end insert or safety lock screw for running track (1 set)	–		For running track ⑤ and mounting rail ⑬, ⑰, ⑱ or ⑲	Steel	Galvanized	–	–	941.25.090
Adjustment aid with hex key	–		For adjusting the running gears (height and position)	Plastic	–	90	–	940.42.075



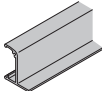

Adjustment aid with hex key

For adjusting the running gears (height and position)

→ Panels

			Area of application	Material	Finish/ colour	Length mm	Width B mm	Cat. No.
Clip panel, for integration in suspended ceilings	ⓐ		For running track ①, ③ and ④	Aluminium	Silver coloured anodized	2000	–	940.43.620
						3000	–	940.43.630
						6000	–	940.43.660
Clip panel, height 33 mm	ⓑ		For running track ①, ③, ④ and ⑤	Aluminium	Silver coloured anodized	2000	–	941.25.620
						3000	–	941.25.630
						6000	–	941.25.660
End cap set for panel ⓐ	–		For running track ①, for running track ⑤, with mounting rail ⑰	Plastic	Silver coloured	–	50	941.25.040
			For running track ⑤, mounting rail ⑰	Plastic	Silver coloured	–	61	941.25.041
End cap set for 2x panel ⓐ	–		For running track ①	Plastic	Silver coloured	–	51	941.25.042
End cap set	–		For running track ⑤, with mounting rail ⑰	Plastic	Silver coloured anodized	–	40	940.43.076
			For running track ⑤ with mounting rail ⑰	Plastic	Silver coloured anodized	–	51	940.43.480

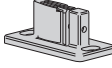
→ Guides

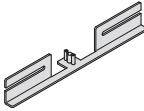
			Area of application	Material	Finish/ colour	Length mm	Cat. No.
Clear threshold floor guide	③①		For wooden doors with or without guide track ③①	Plastic	Black	–	940.42.030
Guide track, bottom, for press fitting	③①		For clear threshold floor guide ③①	Plastic	Black	1000	940.42.050
						1500	940.42.051
						2000	940.42.052
Clear threshold floor guide for wall pocket installation	–		For installation on one or both sides to front side of sliding door wall pocket, for gap width 8–8.5 mm	Steel	Galvanized	245, can be cut to size	940.42.035

Door handles for sliding doors	► BB 3.112
Mortice locks	► BB 4.28
	► BB 9.362
Retractable door seals for sliding doors	► BB 8.17
Wall pocket solution	► BB 9.34
Track stopper	► BB 9.41
Stacking	► BB 9.42
Track cleaner	► BB 9.85
Door seals for sliding doors	► BB 9.136
Flush pull handles	► BB 9.371