

Sliding hardware systems for all-glass doors

HAWA-Junior



HAWA-Junior: A proven all-rounder with solutions for the future

HAWA-Junior has been a success for more than 20 years. A comprehensive sliding hardware system with a broad range of applications and proven million-fold, it is a firm favourite with architects, designers and users alike. Whether sliding glass doors with patch suspension or continuous profile – HAWA-Junior blends harmoniously into any architectural surround. The system's complexity and extensive accessory programme leave plenty of scope for any application – including sliding wooden doors – and offer a wide range of fitting options for doors weighing from 40 up to 250 kg (88 – 550 lbs.).

Hawa AG: a seal of quality for every product

Since its foundation over 40 years ago, Hawa AG has been a benchmark for best workmanship, precise finishing and high quality. Switzerland always was and still is our location of choice for all our production work. After all, our business philosophy is based on typical Swiss values such as safety, precision, durability and high quality of service.



Another seal of quality: the certificate issued by the LGA Bayern, Bavaria's trade and industry institute, which has attested the high quality of workmanship and durability of many Hawa products.

Page 4–11
Systems

Page 12–15
Accessories

Page 16–19
Individual parts

Contents

Page 4–5

HAWA-Junior 40–160/GP
Sliding hardware with patch suspension

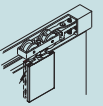

Page 6–7

HAWA-Junior 40–80/GL
Sliding hardware with glass retainer profile

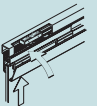

Page 8–9

HAWA-Junior 80–250/G
Sliding hardware for lightweight to heavyweight all-glass sliding doors

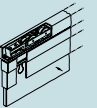

Page 10

HAWA-Telescopic 80/G
Additional hardware for telescopic opening and closing



Page 11

HAWA-Symmetric 80/G
Additional hardware for symmetric opening and closing



Page 12

HAWA-Adapto 80–120
Additional hardware for symmetric opening and closing

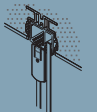

Page 13

HAWA-Toplock
The elegant top lock



Page 14

Angled profile
The clever wall fixing unit



Page 15

HAWA-SoundEx
Effective insulation against structure-borne noise

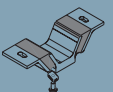

Page 16–19

Individual parts
Systems/Supplements

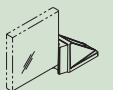

Patch suspension hardware for elegant sliding glass doors

HAWA-Junior 40 – 160/GP

About the product

The HAWA-Junior 40–160/GP fulfills every optical, technical and quality-related requirement one could demand from sliding hardware. It easily moves heavy-weights of up to 160 kg (352 lbs.) with silent smoothness. It does not require a cover and, with plain anodized or stainless steel-look top tracks and cover plates in various forms and colours, it ties in well with any architectural style. The top end is characterised by a low installation height, whilst down below rattle-proof floor guides prevent any undesirable rattling noise. And the form-fitting connection of glass and hardware guarantee that the glass is held securely in place. The HAWA-Junior 40–160/GP is nonetheless easy to assemble, saving both time and money.

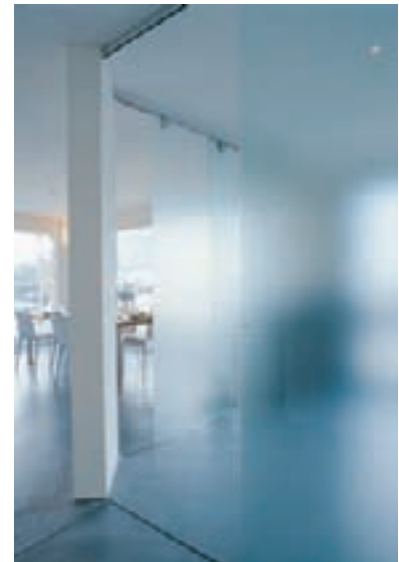

HAWA-Junior GP: for glass thicknesses of 8–12.7 mm ($\frac{5}{16}$ " – $\frac{1}{2}$ ")

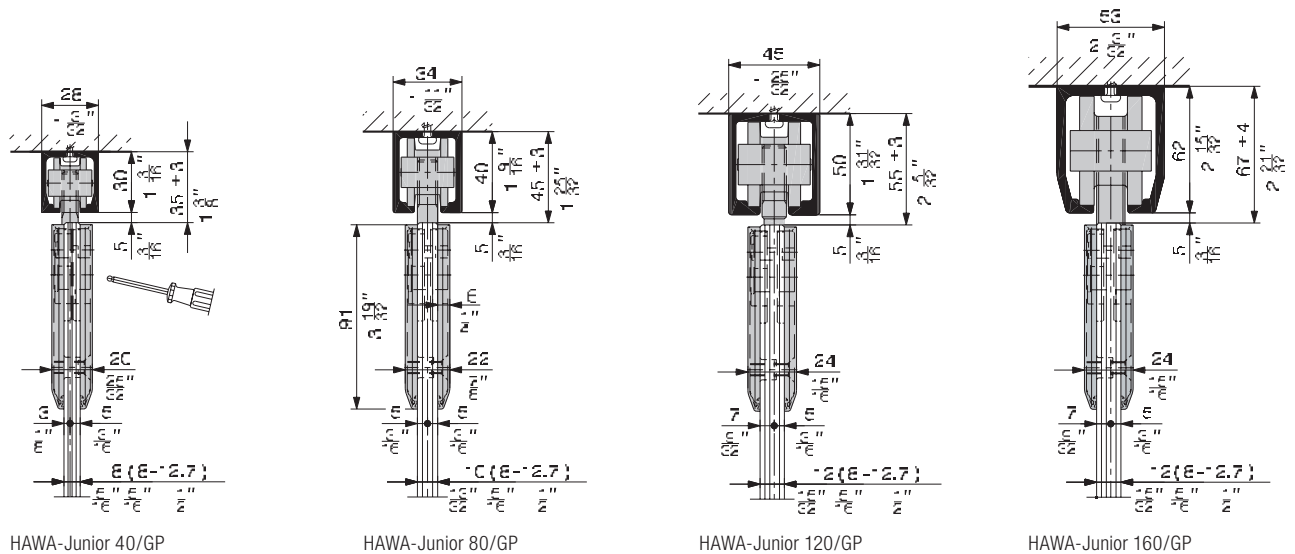



Angular and rounded cover plates: either way a joy to behold.

Technical specifications

Max. door weight 40–160 kg
(88 – 352 lbs.)

Glass thickness sliding door
ESG 8/10/12/12,7mm ($\frac{5}{16}$ "/ $\frac{13}{32}$ "/ $\frac{15}{32}$ "/ $\frac{1}{2}$ "")

VSG 8,7 – 12,7 mm ($\frac{11}{32}$ "/ $\frac{1}{2}$ "")

Glass thickness stationary glass
ESG/VSG 10–12 mm ($\frac{13}{32}$ "/ $\frac{15}{32}$ "")

At a glance

- Tandem roller corrosion-proof trolleys with sliding bearings for optimum running smoothness.
- Cover plates in a stainless steel, chrome or brass look, or untreated, ready for painting on site.
- Top tracks and angled profiles in a stainless steel and look, plain anodized, or untreated, ready for painting on site.
- High degree of comfort thanks to a stop bumper, adjustable to suit the door weight.
- Top track with retainer profile for stationary glass. Suspension burglar-proof thanks to inside mounting.
- Both toughened safety glass (ESG) and laminated safety glass (VSG) can be used.
- Rattle-proof floor guides prevent rattling caused by drafts.
- Clip-on or glue-on floor guides with a height of 4.5 mm ($\frac{3}{16}$ ") give wide doors more stability.
- Based on standard Hawa components, simplifying storage and logistics.
- Large range of accessories.

Top track with retainer profile for stationary glass for HAWA-Junior 40–80–120/GP

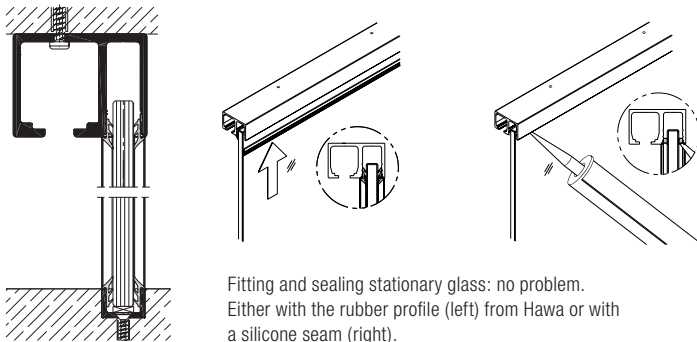

Fitting and sealing stationary glass: no problem. Either with the rubber profile (left) from Hawa or with a silicone seam (right).



The hardware with an aesthetic profile for all-glass sliding doors

HAWA-Junior 40 – 80/GL

About the product

The HAWA-Junior 40 – 80/GL is an appealing solution for sliding glass doors with a door weight of 40 to 80 kg (88 to 176 lbs.) and a width of up to 1200 mm (3'11 1/4"). The technology disappears behind flexible covers and a continuous, straight-line profile, also available in a stainless steel look. Not that it needs to hide itself away: smooth running properties, dry glazing with a form-fitting connection between glass and hardware, clip-on aluminium covers, rattle-proof floor guides and stopper technology with adjustable bumpers are all reason enough to find this versatile hardware more than fascinating.

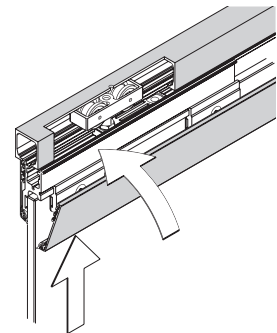

Just clip it on:
aluminium profiles.



Beautiful living with HAWA-Junior 40–80/GL.

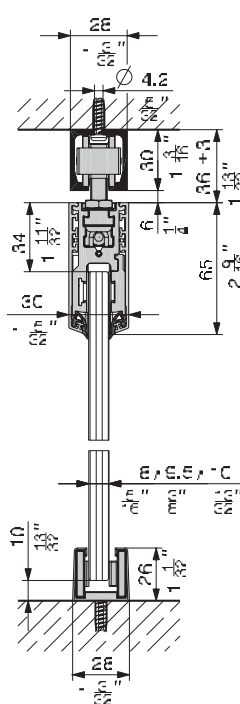

HAWA-Junior 40/GL

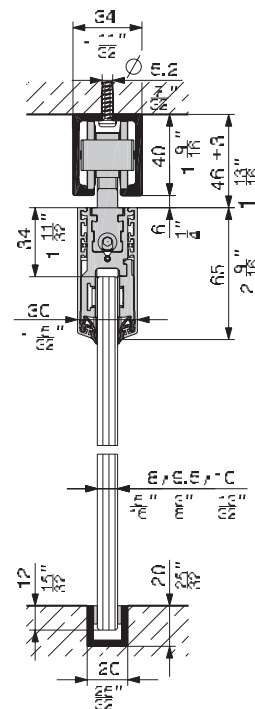

HAWA-Junior 80/GL

Technical specifications

Max. door weight 40–80 kg
(88 – 176 lbs.)

Door width 500–1200 mm
(1'7 ¹¹/₁₆" – 3'11 ¹/₄"

Glass thickness sliding door

ESG 8/9.5/10 mm (⁵/₁₆" / ³/₈" / ¹³/₃₂"

Glass thickness stationary glass

ESG/VSG 10–12 mm (¹³/₃₂" / ¹⁵/₃₂"

At a glance

- Straight-lined and straight-forward, a design to harmonise with any environment.
- High-quality, smooth-running sliding technology, proven time and again.
- Cover profiles, top tracks and angled profiles in a stainless steel look, plain anodized, or untreated, ready for painting on site.
- Rattle-proof floor guides prevent rattling caused by drafts.
- Aluminium profiles simply clip on. Comfortable operation thanks to a stop bumper, adjustable to suit the door weight.
- Very secure glass mounting, even when subject to heavy use and weather changes.
- Top track with retainer profile for stationary glass.

Top track with retainer profile for stationary glass for HAWA-Junior 40–80/GL

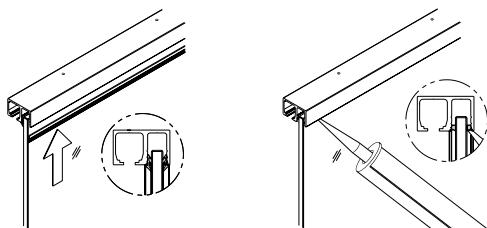
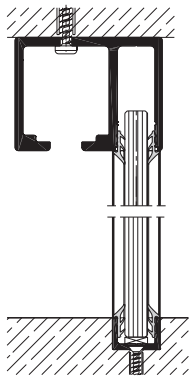

Fitting and sealing stationary glass: no problem.
Either with the rubber profile (left) from Hawa or with a silicone seam (right).

HAWA-Junior 80 – 250/G



Light moving heavy doors:
A light feat for HAWA-Junior 250/G
but not for the competition.

About the product

It is now possible to make moving even large-surface all-glass doors as light and elegant as they look. This is because the HAWA-Junior 80–250/G, which incorporates the high-quality HAWA-Junior technology proven millionfold around the world, lets doors weighing up to 250 kg (550 lbs.) run as smoothly as a dream. Technically perfect room partitions with aesthetic appeal are now possible in virtually any situation – in shop-fitting and gastronomy just as in banks, offices and private buildings. All the more so considering the excellent looks of the hardware's simple, filigree profile and invisibly integrated technology. And its low installation height leaves nothing to be desired when it comes to fitting.

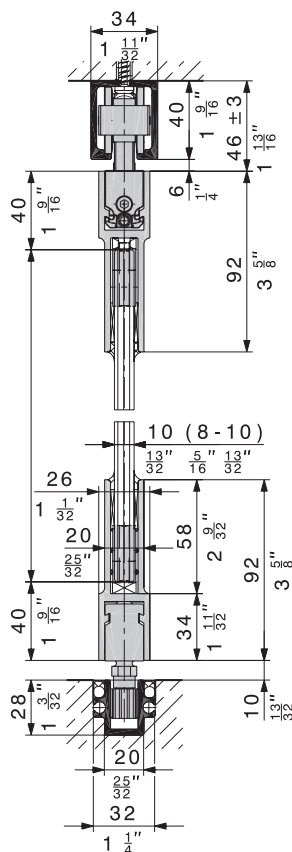
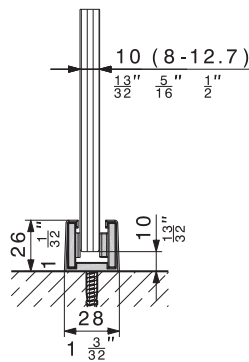

HAWA-Junior 80/G

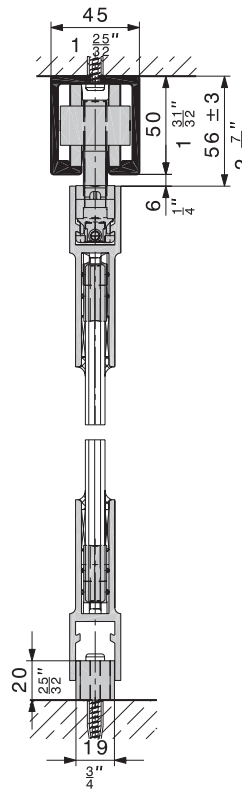

HAWA-Junior 120/G

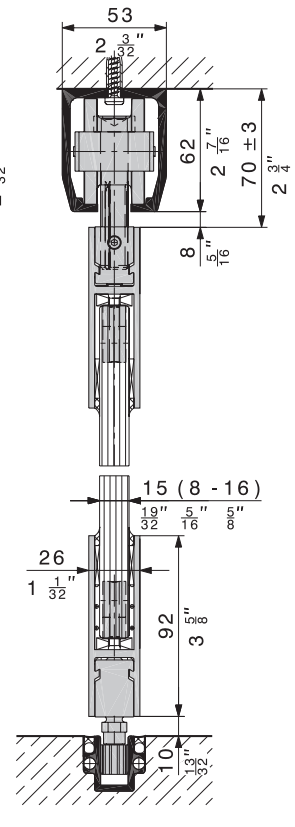

HAWA-Junior 160/G

At a glance

- Quiet running for glass sliding doors up to 250 kg (550 lbs.).
- Best sliding properties and a long lifetime thanks to high-quality plastic rollers and plain anodised tracks.
- Form-fitting glass connection for the greatest possible safety of use.
- Elegant profile design with high optical adaptability.
- Bar bolt locks for integration in locking systems.
- Invisible, point-fixing floor guide or stable two-point guide in floor track, depending on frequency of use.
- Track stops with retainers easily adjustable to the specific door weight.
- Various accessories available.

Technical specifications

HAWA-Junior 80-160/G
 Door weight up to 80, 120, 160 kg
 (176, 261, 352 lbs.)

Glass thickness 8-16 mm
 ($\frac{5}{16}$ " - $\frac{5}{8}$ ")

Height adjustable ± 3 mm ($\frac{1}{8}$ ")

HAWA-Junior 250/G

Max. door weight 250 kg
 (550 lbs.)

Glass thickness 8-16 mm
 ($\frac{5}{16}$ " - $\frac{5}{8}$ ")

Height adjustable ± 5 mm ($\frac{7}{32}$ ")

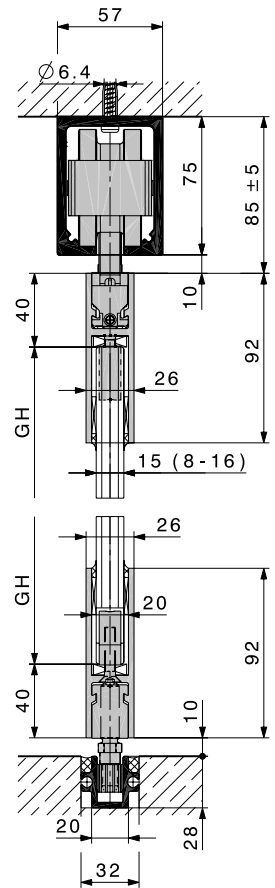
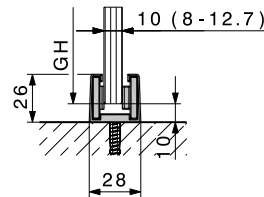
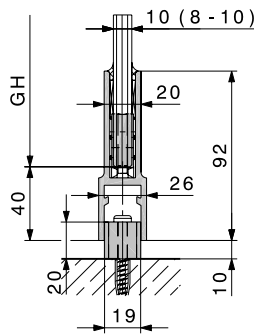

HAWA-Junior 250/G



Glass cut out
 HAWA-Junior 80-160/G.

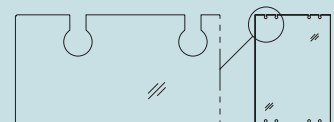

Glass cut out
 HAWA-Junior 250/G.

HAWA-Telescopic 80/G



About the product

Lack of space is at last no longer a reason to miss out on elegant sliding doors. A sliding hardware system that can move two glass sliding doors simultaneously is now on the market with HAWA-Telescopic 80/G. It only needs half the closing space when open, which is why it scores particularly well when it comes to separating smaller rooms such as kitchens, bathrooms or offices. And because the HAWA-Telescopic 80/G is based completely on the HAWA-Junior technology it leaves nothing to be desired with regard to running smoothness, durability and ease of assembly.

At a glance

- Simultaneous, space-saving sliding of two glass doors up to 80 kg (176 lbs.) with smooth and quiet running properties.
- Reliable system based on HAWA-Junior technology, proven millionfold around the globe.
- Long lifetime thanks to high-quality plastic rollers, fibreglass-reinforced toothed belts and maintenance-free technology.
- High stability through continuous floor guide track (optional).
- Track stops with adjustable retention force.
- Elegant glass retainer profiles, available untreated and plain anodised.
- Combinable with a safety lock, wall profile and further accessories.

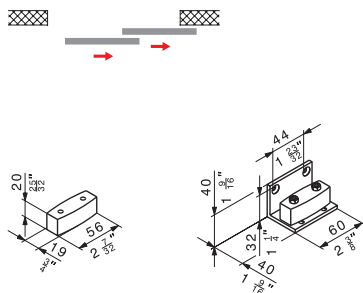

Point-fixing floor guides.

Technical specifications

Max. door weight	80 kg (176 lbs.)
Door width	500–1000 mm (1'7 ¹¹ / ₁₆ " – 3'3 ³ / ₈ "
Max. door height	2600 mm (8'6 ³ / ₈ "
Glass thickness	8–16 mm (⁵ / ₁₆ " – ⁵ / ₈ "
Height adjustable	± 2 mm (³ / ₃₂ "

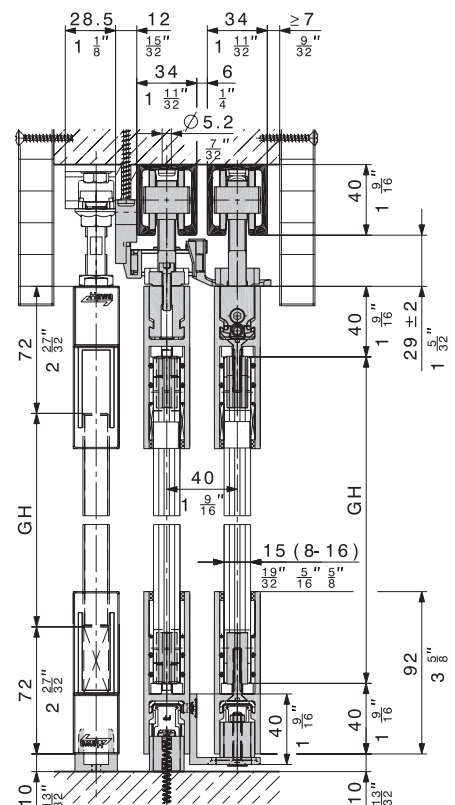
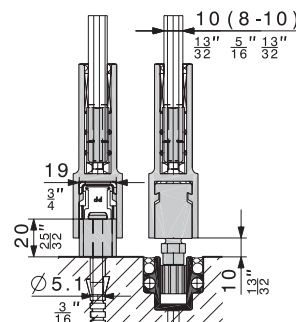

HAWA-Symmetric 80/G

About the product

Imagine elegantly opening all-glass sliding doors with just one hand: light work for the HAWA-Symmetric 80/G. This sophisticated hardware solution connects two sliding doors via a toothed belt fed over deflection rollers to simultaneously open or close glass sliding doors weighing up to 80 kg (176 lbs.). It is pleasing to know you won't hear any noise from the top end due to the smooth running properties of the HAWA-Symmetric 80/G. Neither will you see much of its bottom end as there is no sign of a visible floor guiding system across the entire width.

Technical specifications

Max. door weight	80 kg (176 lbs.)
Glass thickness	8-16 mm ($\frac{5}{16}$ " - $\frac{5}{8}$ ")
Height adjustable	± 3 mm ($\frac{1}{8}$ ")

At a glance

- Symmetric opening and closing of two sliding doors.
- High-quality trolleys enable easy sliding even with just one hand.
- Fibreglass-reinforced toothed belts guarantee high tear resistance and minimum stretch.
- Simple installation: hang doors and attach toothed belt from one side.
- High stability through a continuous floor guide track (optional).
- Track stops with adjustable retention force.
- Elegant glass retainer profiles, available untreated and plain anodised.
- Combinable with a safety lock, wall profile and other accessories.

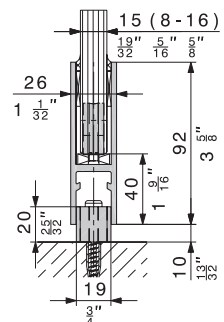
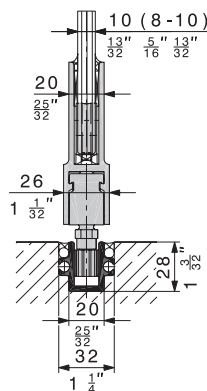
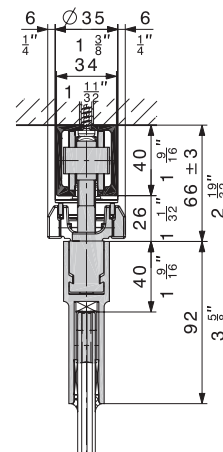
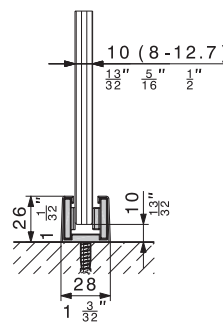

The system for concreting top tracks into the ceiling

HAWA-Adapto 80–120



Visible aesthetics, invisible technology:
HAWA-Adapto.

About the product

Minimalism is in, and the new HAWA-Adapto 80–120 profile for HAWA-Junior 80 and 120 top tracks make designer hearts beat faster. The profile can be set in concrete and provides an elegant transition between top track and ceiling plaster. The effect of the integrated technology is amazing: glass (and wood) door elements weighing from 80 to 120 kg (176 do 264 lbs.) seem to hang weight-lessly in the air. And installation is particularly cost-effective as the HAWA Adapto 80–120 is fitted to the shuttering before the ceiling is cast – subsequent risky drilling in the ceiling is no longer necessary.

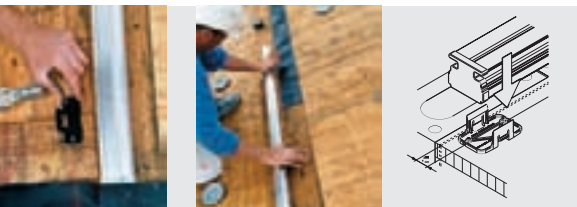

HAWA-Adapto assembly: nail plastic clips to shuttering, clip on profile, pour concrete – job done.

At a glance

- For sliding glass and wood doors and stationary glass for HAWA-Junior 80 and 120.
- Ceiling-flush assembly without the need for a hanging ceiling or screw-on tracks.
- Profiles fit exactly and easily to the shuttering thanks to plastic clips.
- Front covers and polystyrene inserts prevent concrete from seeping in.
- The top tracks are screwed into the profile, no drilling required.
- Top tracks are easily levelled.

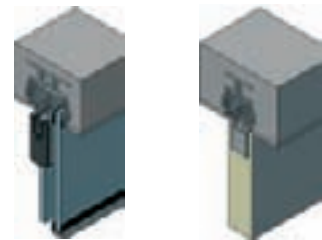

Sliding glass door
and stationary glass.

Sliding wood door.

Technical specifications

Max. door weight 80–120 kg
(176 – 264 lbs.)

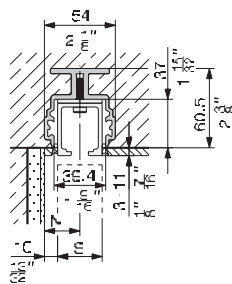

HAWA-Adapto 80

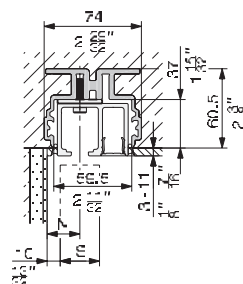

with retainer for
stationary glass.

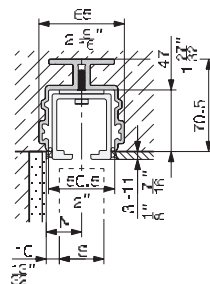

HAWA-Adapto 120

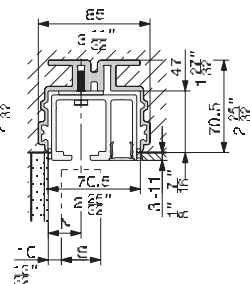

with retainer for
stationary glass.

The lock designed for glass doors

HAWA-Toplock

About the product

The perfect lock to complement the airy lightness of glass. HAWA-Toplock is the integrated solution, matching HAWA-Junior hardware perfectly in form and colour. Whether chrome-plated, brass, stainless steel or untreated ready for painting: HAWA-Toplock and its clever plastic covers always look the part. The lock has two convincing arguments to offer: aesthetic appeal and high security. The high-quality all-glass sliding door lock for 17 mm ($\frac{11}{16}$ " profile cylinders, 22 mm ($\frac{7}{8}$ " round cylinders or 8 mm ($\frac{5}{16}$ " square-cut locks safely secures sliding doors and can also lock up two-door installations and wall connections with the corresponding accessories.



At a glance

- A development designed for HAWA-Junior hardware.
- Rounded or square clip-on covers in various surface finishes.
- Can be used on the left or the right hand side.
- Both toughened safety glass (ESG) or laminated safety glass (VSG) can be used.
- Rubber stop integrated in the strike plate.
- A top solution for toilets, too, thanks to square-cut locks.
- Safe and easy assembly.
- Many accessories for wall-mounted locks or two-door systems.
- Wall profile with integrated strike plate and rubber stop.

Technical specifications

Glass thickness

ESG 8/10/12/12.7mm ($\frac{5}{16}$ "/ $\frac{13}{32}$ "/ $\frac{15}{32}$ "/ $\frac{1}{2}$ "

VSG 8.7 – 12.7 mm ($\frac{11}{32}$ " – $\frac{1}{2}$ "

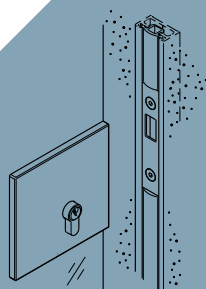

Wall-mounted fixture with integrated striking plate.

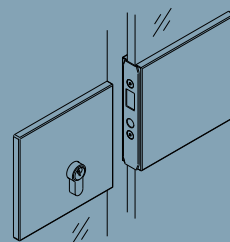

With counter case for two-door systems.

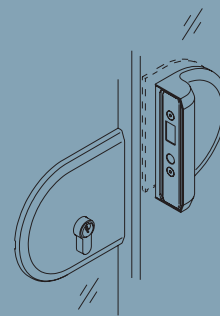

Striking plate for stationary glass.

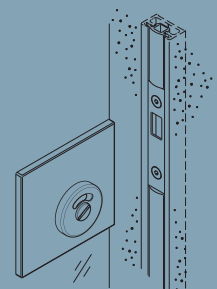

Square-cut variant (rosette by others).

Angled profile

About the product

Elegance, speed and safety are words that best describe the properties of HAWA's angled profiles for wall-mounted glass and wood sliding doors. After all, HAWA's ingenious angled profile is assembled in a flash, using slot nuts to clamp the top tracks in place. It does not require any other kind of substructure. HAWA-Junior top tracks are anodised as standard and do not require covers. And levelling is simple due to the continuous profile. There are no additional drill holes in track or profile, keeping running surfaces smooth and clean. And the attractive cover plates give the solution an aesthetic and distinguished appeal.

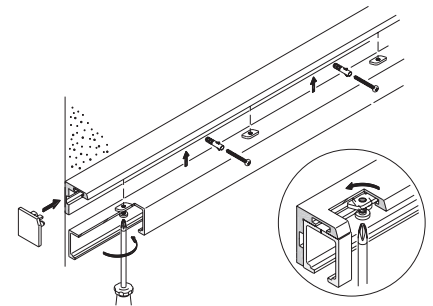

Assembly could not be easier:
angled profile for wall mounting.

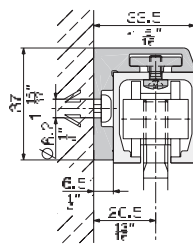

HAWA-Junior 40 Glass

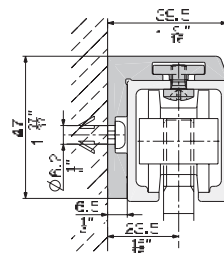

HAWA-Junior 80 Glass

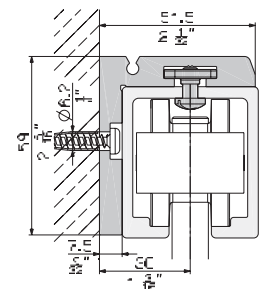

HAWA-Junior 120 Glass

Technical specifications

Max. door weight 40–120 kg
(88 – 264 lbs.)

At a glance

- Practically invisible profile.
- No covers needed.
- Elegant front finish with clip-on cover plates.
- Quick assembly – top tracks are clamped using groove nuts.
- No additional drilling, no dirt or soiling.
- Very simple to level due to continuous profile.
- Suitable for all HAWA sliding glass systems up to 120 kg (264 lbs.).
- Also available with separate profiles for sliding wood doors up to 45 mm (1 25/32") thick.



The noise protection bracket for eliminating structure-borne noise

HAWA-SoundEx



Sliding could not be more silent:
HAWA-SoundEx combined with HAWA-Junior
sliding hardware systems.

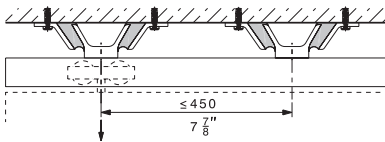

About the product

We like to shout it out loud: HAWA-Junior hardware systems with their high-quality trolleys are probably the quietest sliding systems of them all. However, in some buildings even they can sometimes transfer vibrations to the structure. HAWA-SoundEx puts a stop to that once and for all. HAWA's sound absorbing brackets are fitted quickly and easily to the ceiling. The top tracks are then secured to the bracket using slot nuts pushed through the original drill holes. The result is peace and quiet in the surrounding rooms.

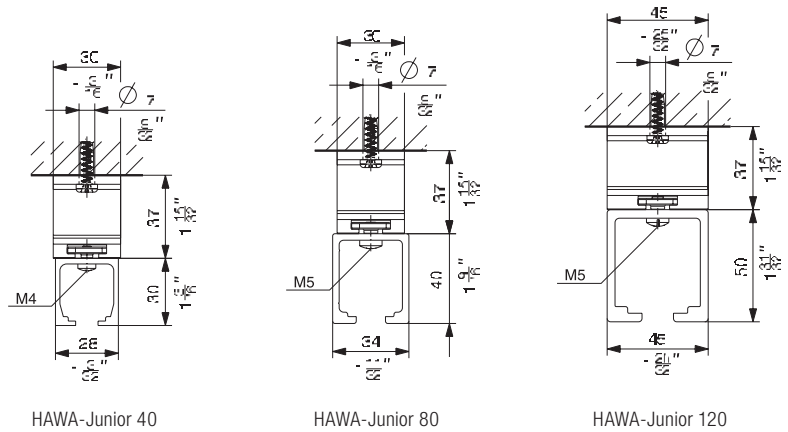

HAWA-Junior 40

HAWA-Junior 80

HAWA-Junior 120

Technical specifications

Max. door weight 40–120 kg
 (88 – 264 lbs.)

At a glance

- Prevents the transfer of vibrations.
- Quick and easy assembly – top tracks are fitted to the sound absorbing bracket using groove nuts.
- Assembly with large tolerance in direction of travel.
- Suitable for all HAWA-Junior sliding hardware systems for glass and wood up to 120kg (264lbs.).

Individual parts

Continuous floor guide

Although only 4.5 mm ($\frac{3}{16}$ ") high, this track is clipped or glued on and guides doors at both ends with a high level of stability.



Discreet and continuous floor guide – ideal for wide doors.

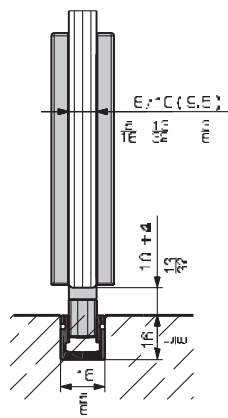

Floor-flush

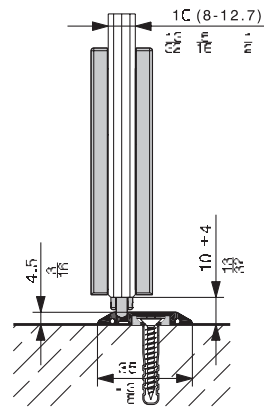

or floor-mounted.

Rattle-proof floor guide

A patented Hawa innovation: punctiform, rattle-proof guide for silent and safe running which also prevents rattling caused by drafts. Available in stainless steel or a dull chrome finish.

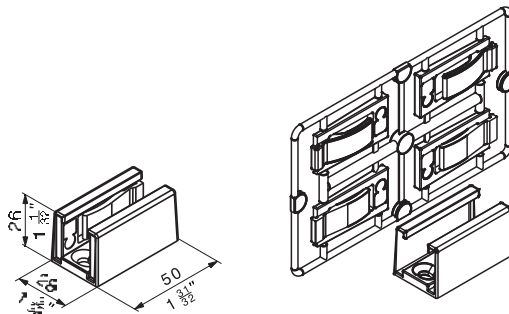

Rattle-proof floor guides – for glass thicknesses of 8, 10, 12, 12.7 mm ($\frac{5}{16}$, $\frac{13}{32}$, $\frac{15}{32}$, $\frac{1}{2}$).

Wall profile with centering assemblies

Easily fitted and quickly positioned: the profile with an integrated rubber stop is the perfect wall fixture for all-glass sliding doors with unprotected glass edges, for instance the HAWA-Junior GP.

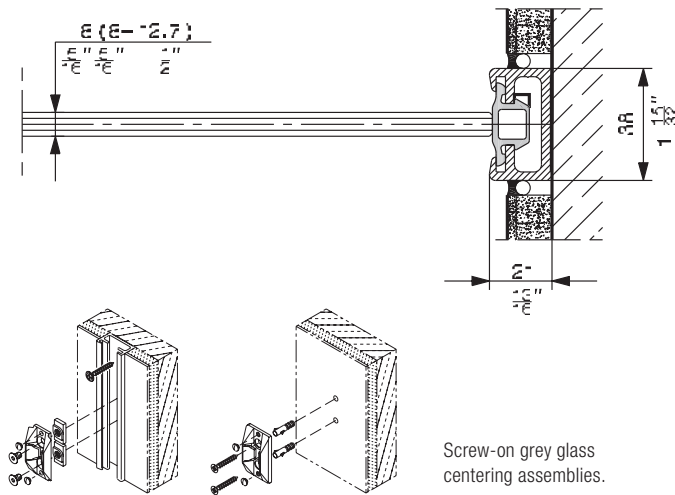

Black glass centering assemblies integrated in wall profile.

Bottom door stopper

Because sliding doors should be stopped simultaneously top and floor: matt chrome-plated floor door stopper from Hawa. Stops doors of up to 250 kg (550 lbs.) gently and quietly. Available in stainless steel or a dull chrome finish.

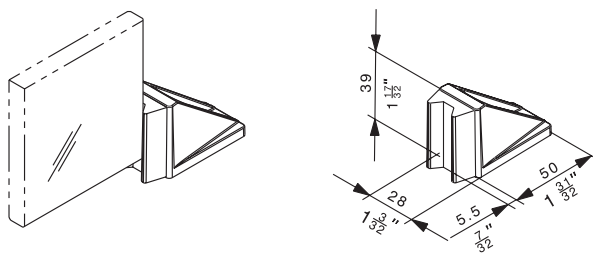

Vertical sealing profile

The vertical sealing profile takes a stand against draught. It has been designed for the HAWA-Junior 40–80–120/GP and HAWA-Junior 40–80/GL sliding glass door systems and unfolds its full effect in combination with stationary glass. The rubber seal drawn into the profile consists of two components and has three advantages: it glides virtually noiselessly, creates very little friction, and looks impeccable even after years, which cannot be said for conventional brush seals.

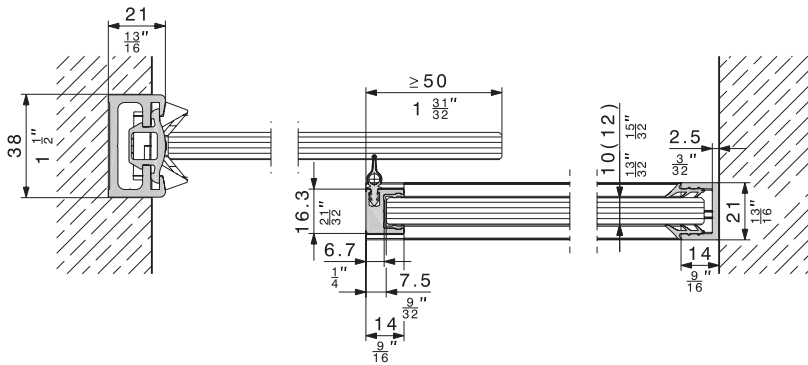

The slimline aluminium profile is frontally bonded to 10 mm (13/32") or 12 mm (9/16") glass elements with silicone.

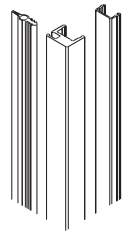

Rubber profile for protecting glass edges

This self-adhesive rubber profile fits onto the glass edge in seconds. It protects against drafts and prevents the edges of sliding glass doors from being damaged through collision.

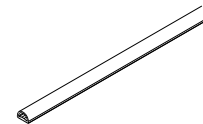
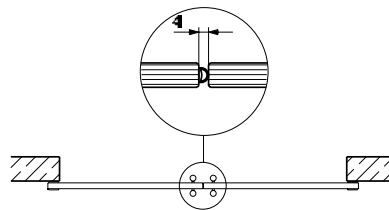

Available in black and translucent for glass thicknesses of 8 and 10 mm (5/16"/13/32").

Sliding in a trendy stainless steel look

Hawa offers sliding systems in a trendy stainless steel look and as well in plain anodised.



Sliding solutions can be beautiful.

Products currently available in a stainless steel look

- Top tracks for HAWA-Junior sliding glass and wood doors from 40 to 80 kg (88 to 176 lbs.).
- Angled profile for wall mounting the HAWA-Junior 40–80 in glass.
- Cover profile for HAWA-Junior 40–80/GL.
- Cover plates, rounded and angled, for HAWA-Junior GP, HAWA-Ordена 70 and the HAWA-Toplock.
- Wall connecting profile for all-glass sliding doors such as the HAWA-Junior GP.
- Rattle-proof floor guide and bottom door stopper.
- Vertical seal profile.

Available from specialist dealers

Further information:

Hawa AG
CH- 8932 Mettmenstetten
Switzerland
Tel. +41 44 767 91 91
Fax +41 44 767 91 78
www.hawa.ch

